

### Teile Übersicht: Grow Box

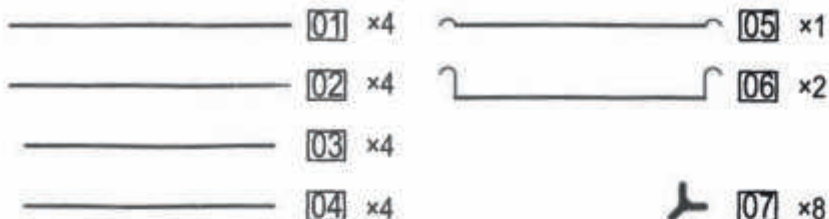

#### MONTAGE: GrowBox

1. Legen Sie das Zelt aus und stellen Sie sicher, dass alle Reißverschlüsse 1 vollständig geöffnet sind.

Bauen Sie den Zeltrahmen wie unten beschrieben zusammen.

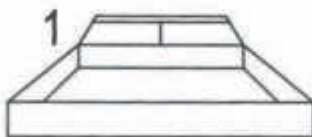

2. Stecken Sie die Stangen #01 und #03 & #04 in jeden #07 Verbinder auf den Seiten ein, wie in Abbildung 2 gezeigt.

3. Stecken Sie die Stangen #02 und #03 & #04 in jeden #07 Verbinder auf den Seiten ein, wie in Abbildung 3 gezeigt.

4. Verbinden Sie die beiden Teile, wenn Sie Schritt 2 und 3 abgeschlossen haben, wie in Abbildung 4 gezeigt, tun Sie dies am besten mit Hilfe einer anderen Person.

Jetzt haben Sie den Zusammenbau des Rahmens abgeschlossen.

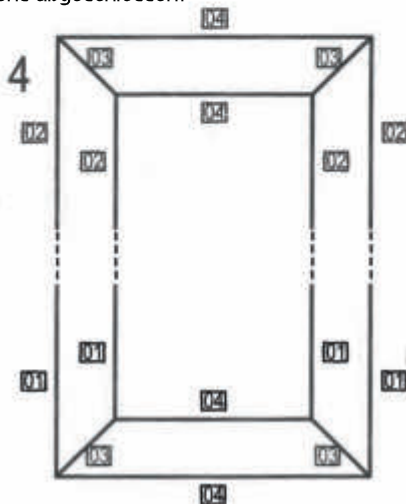
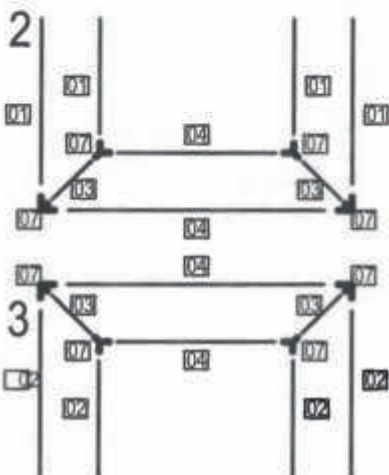

5. Stellen Sie den Rahmen in den Zeltboden, wie in Bild 5 gezeigt, und dann die Rückseite, stellen Sie sicher, dass das Zelt nicht verschlossen ist.

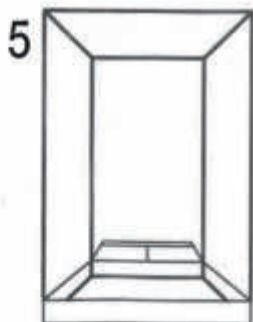

6. Legen Sie den oberen Teil des Zeltes über den Rahmen und schließen Sie die Reißverschlüsse auf der linken und rechten Seite.

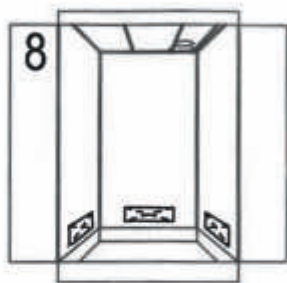
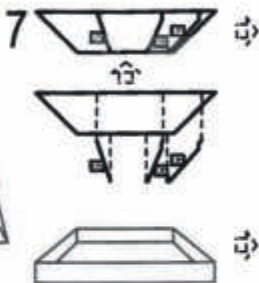
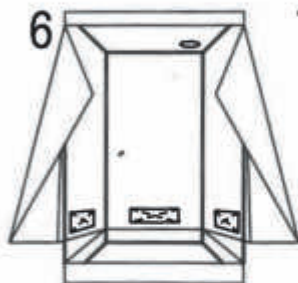

9. Schließen Sie alle Reißverschlüsse und ziehen Sie die Zeltdecke gerade.

10. Abbildung 10 zeigt die empfohlene Installation für Ihren Filter und Ihr Pflanzenlicht.

Der Filter wird zwischen oder unter den Filterarmaturen (7) angebracht.

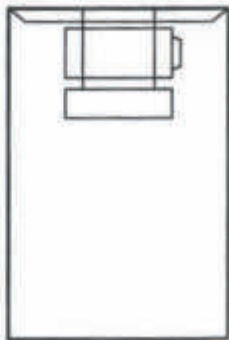
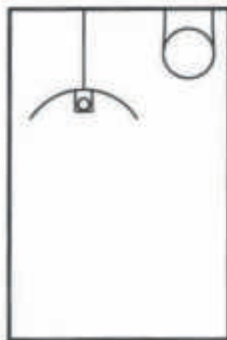
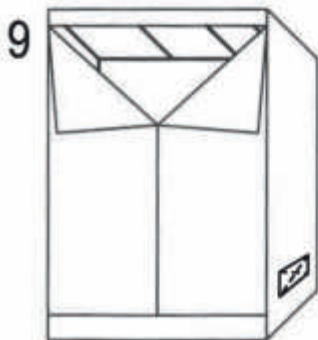
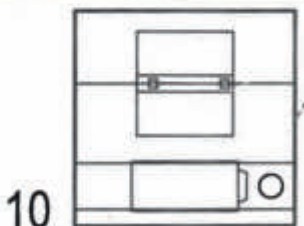

### Part List: Grow Tent

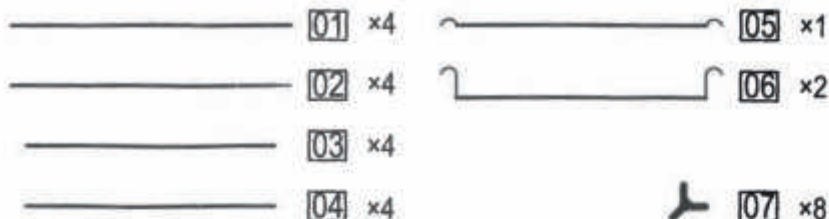

#### ASSEMBLY: GrowTent

1. Lay out the growtent making sure all the zips 1 are completely undone, this piece is for the bottom section.

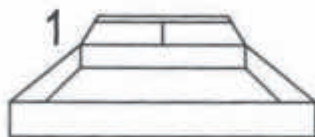

Assemble the tent frame as detailed.

2. Insert poles #01 and #03 & #04 to each #07 connector on the other two ways as picture 2 shown.

3. Insert poles #02 and #03 & #04 to each #07 connector on the other two ways as picture 3 shown.

4. Connect the two parts when you have finished step 2 and 3 as picture 4 shown, you'd better do this with other people.

Now you have finished the assembling of the frame.

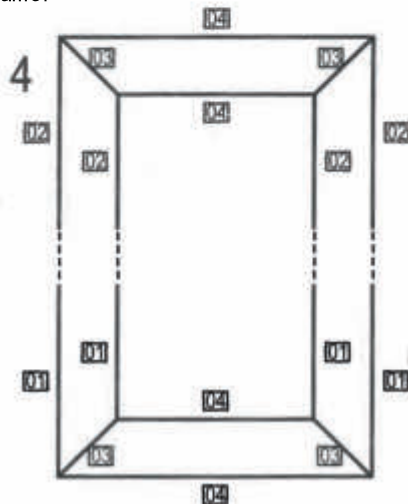
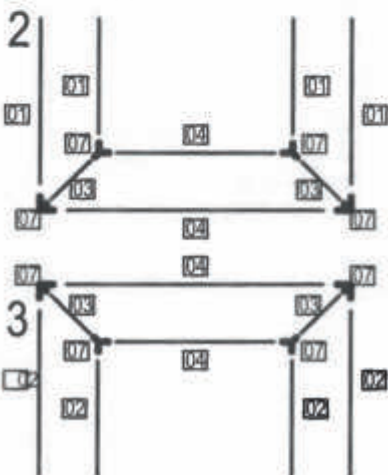

5. Put on the canvas to the frame from the bottom as picture 5 shown, and then the back side, make sure the 5 canvas is unzipped.

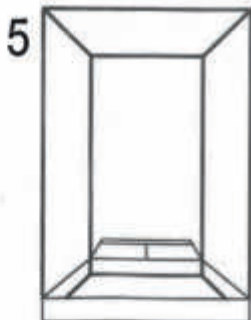

6. Put on the top part of the canvas then close the zippers from both left and right sides.

7. Put poles #05 and #06 on the top of the frame as picture 7.

8. Insert the Grow Tent tray liner and attach to with Cable tie fastening to pole.

All parts have been assembled.

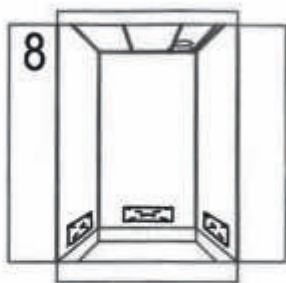
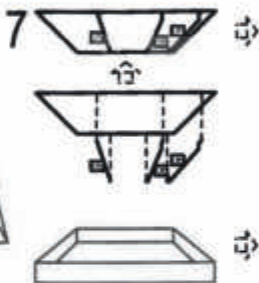
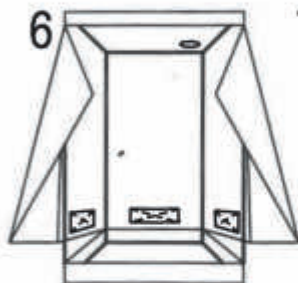

9. Close all the zippers and make final adjustments to the canopy.

10. Figure 10 shows the recommended installation for your filter and growlight.

The filter is positioned between or affixed underneath the filter fixtures (7).

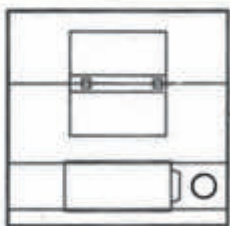

10

